

1 2 3 4 5 6

REVISIONS					
LTR	DESCRIPTION	DATE	REV.	CHKD.	APVD.

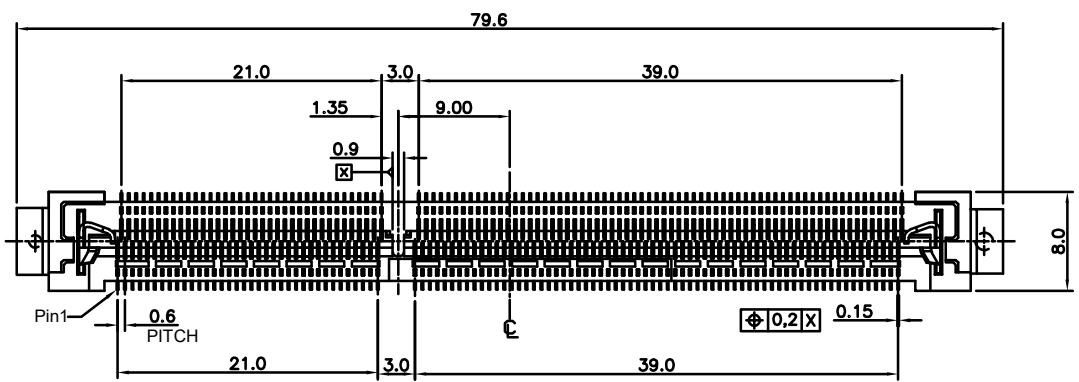

SPECIFICATION:

1. Current Rating: 0.5A
2. Voltage Rating: 25V AC
3. Contact Resistance: 60mΩ max.
4. Insulation Resistance: 500MΩ Min.
5. Dielectric Withstanding Voltage : 125VAC
6. Durability : 25 Cycle
7. Operating Temperature Range : -40°C~+85°C

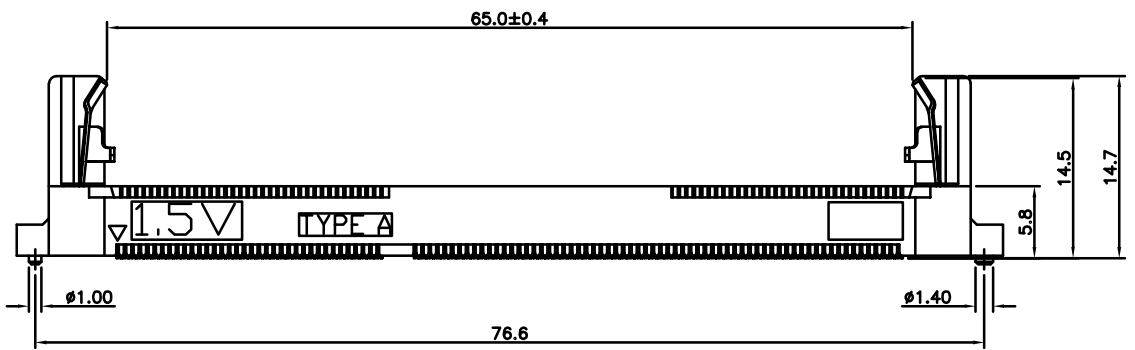

120~315	±0.50	DWN	王淳新	DATE	2019.01.25	SCALE 1.6/1	NAME	SO-DIMM DDR3		
30~120	±0.35	DSND	王淳新	DATE	2019.01.25		PROJECTION	CAT. NO.	KMCX4DR3V0A11	
6~30	±0.25	CHKD	李阮龍	DATE	2019.01.25	UNIT:mm	DWN.NO.	A-CX4DR3V0A11		
BELOW 6	±0.20	APVD	郭遠峰	DATE	2019.01.25		1/3	001		
DIMENSION	TOLERANCE	KUNMING ELECTRONICS CO.,LTD.								

REVISIONS					
LTR	DESCRIPTION	DATE	REV.	CHKD.	APVD.

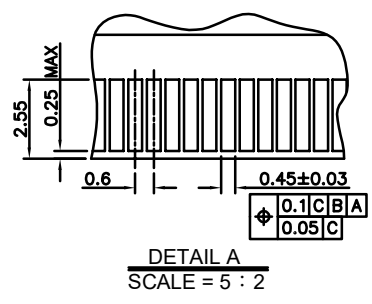
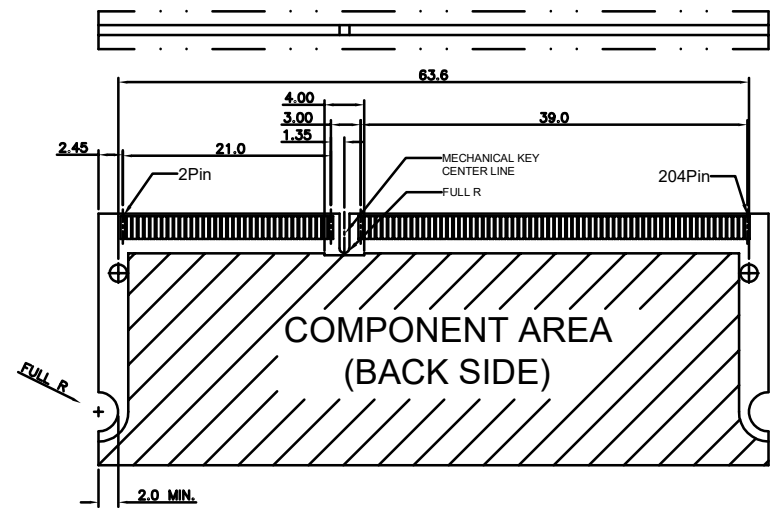
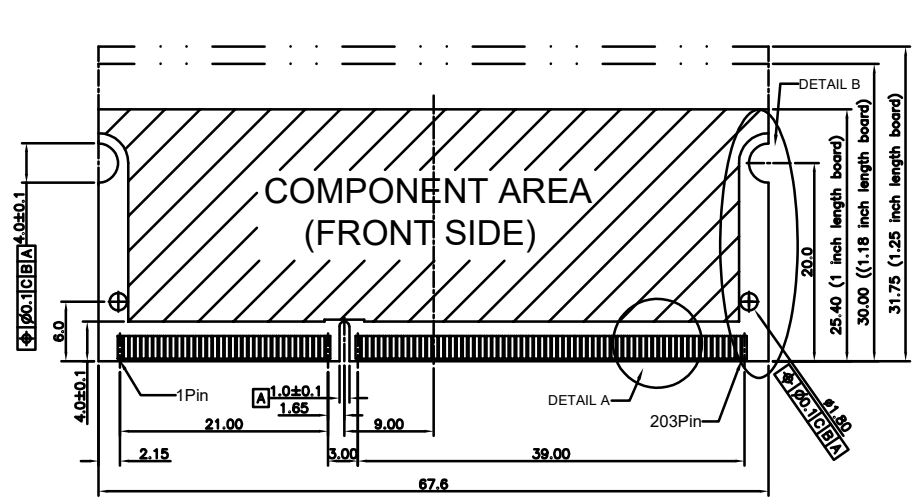

NOTES:

1. TOLERANCES ON ALL DIMENSION ±0.15 UNLESS OTHERWISE SPECIFIED.
2. P.C.BOARD THICKNESS APPLIES ACROSS TABS AND INCLUDES PLATING AND/OR METALIZATION.
3. FINISH OF PAD : GOLD PLATING 0.00076MIN. OVER Ni PLATING 0.002MIN.

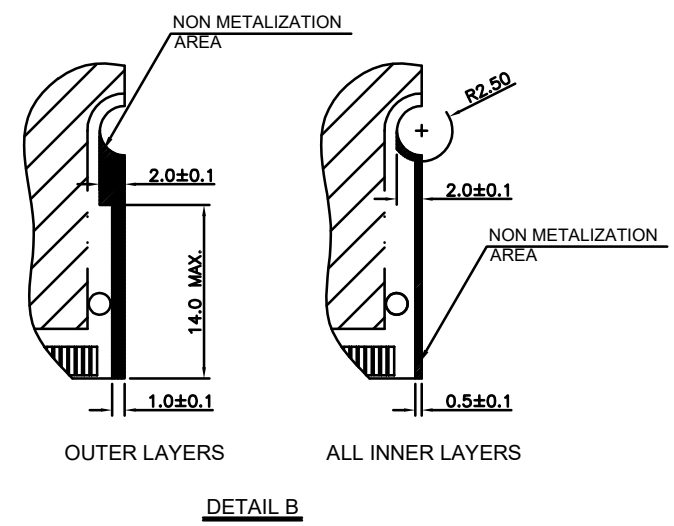

RECOMMEND MATING P.C.BOARD DIM.

120~315	±0.50	DWN	王淳新	DATE	2019.01.25	SCALE 1.6/1	NAME	SO-DIMM DDR3		
30~120	±0.35	DSND	王淳新	DATE	2019.01.25		PROJECTION	CAT. NO.	KMCX4DR3V0A11	
6~30	±0.25	CHKD	李阮龍	DATE	2019.01.25	UNIT:mm	DWN.NO.	A-CX4DR3V0A11		
BELOW 6	±0.20	APVD	郭遠峰	DATE	2019.01.25					
DIMENSION	TOLERANCE	KUNMING ELECTRONICS CO.,LTD.							3/3	001

1 2 3 4 5 6

REVISIONS					
LTR	DESCRIPTION	DATE	REV.	CHKD.	APVD.

A

B

C

D

E

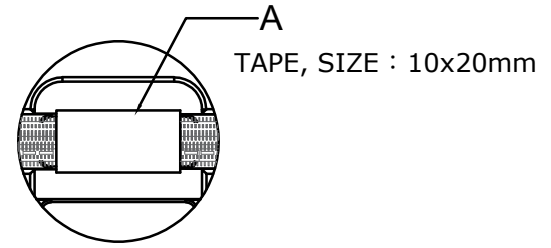
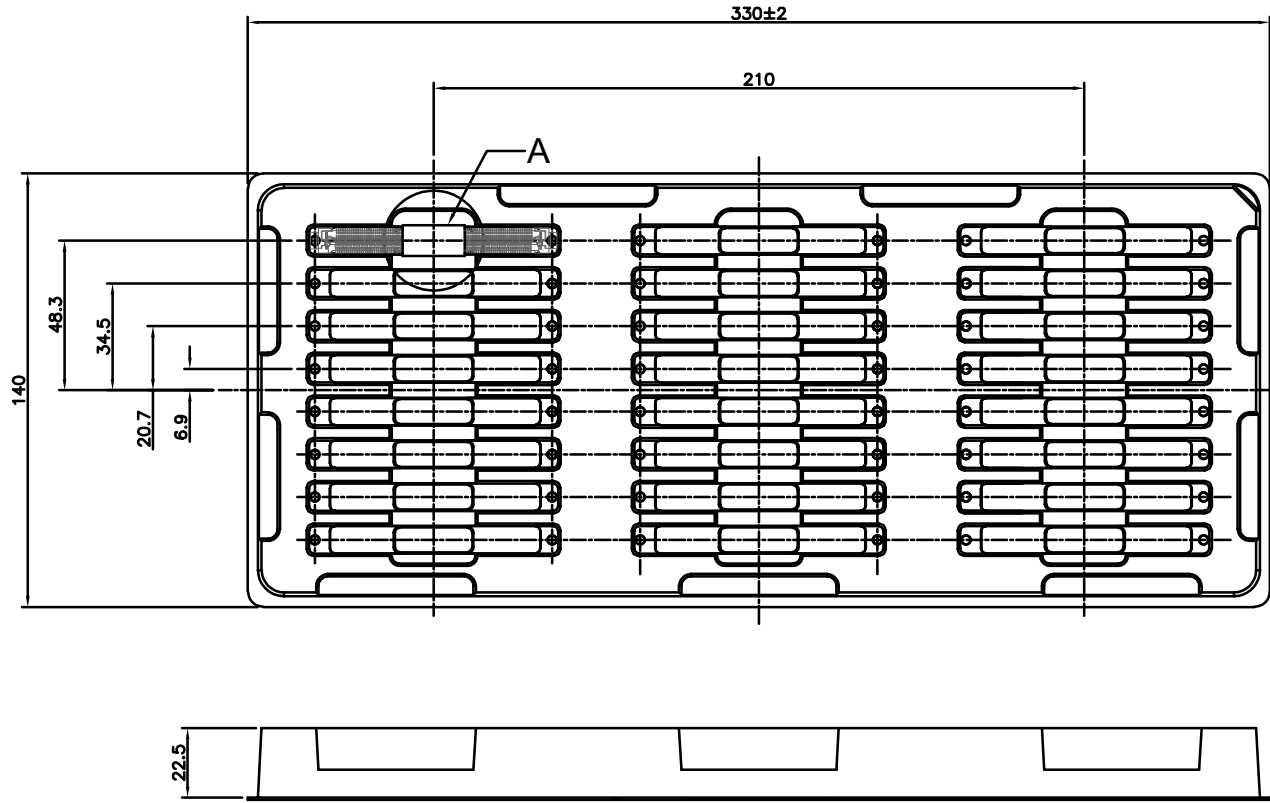

NOTE:

1. 24PCS /Tray
2. 144PCS /Inner Box
3. 432PCS /Carton

120~315	±0.50	DWN	王淳新	DATE	2019.01.25	SCALE 1.6/1	NAME	SO-DIMM DDR3		
30~120	±0.35	DSND	王淳新	DATE	2019.01.25		PROJECTION	CAT. NO.	KMCX4DR3V0A11	
6~30	±0.25	CHKD	李阮龍	DATE	2019.01.25	UNIT:mm	DWN.NO.	1/1		
BELOW 6	±0.20	APVD	郭遠峰	DATE	2019.01.25		P-CX4DR3V0A11	001		
DIMENSION	TOLERANCE	KUNMING ELECTRONICS CO.,LTD.								